

**PAC-MAN**

ARRANGEMENT

TM



**POLE POSITION II**

TM



**NAMCO MUSEUM** TM

**Dixie Out**

ARRANGEMENT

TM

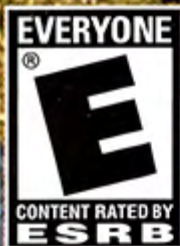

**Galaga**

ARRANGEMENT

TM



**namco**®

## **WARNING: READ BEFORE USING YOUR PLAYSTATION®2 COMPUTER ENTERTAINMENT SYSTEM.**

A very small percentage of individuals may experience epileptic seizures when exposed to certain light patterns or flashing lights. Exposure to certain patterns or backgrounds on a television screen or while playing video games, including games played on the PlayStation 2 console, may induce an epileptic seizure in these individuals. Certain conditions may induce previously undetected epileptic symptoms even in persons who have no history of prior seizures or epilepsy. If you, or anyone in your family, has an epileptic condition, consult your physician prior to playing. If you experience any of the following symptoms while playing a video game – dizziness, altered vision, eye or muscle twitches, loss of awareness, disorientation, any involuntary movement, or convulsions – IMMEDIATELY discontinue use and consult your physician before resuming play.

## **WARNING TO OWNERS OF PROJECTION TELEVISIONS:**

Do not connect your PlayStation 2 console to a projection TV without first consulting the user manual for your projection TV, unless it is of the LCD type. Otherwise, it may permanently damage your TV screen.

## **USE OF UNAUTHORIZED PRODUCT:**

The use of software or peripherals not authorized by Sony Computer Entertainment America may damage your console and/or invalidate your warranty. Only official or licensed peripherals should be used in the controller ports or memory card slots.

## **HANDLING YOUR PLAYSTATION 2 FORMAT DISC:**

- This disc is intended for use only with PlayStation 2 consoles with the NTSC U/C designation.
- Do not bend it, crush it or submerge it in liquids.
- Do not leave it in direct sunlight or near a radiator or other source of heat.
- Be sure to take an occasional rest break during extended play.
- Keep this compact disc clean. Always hold the disc by the edges and keep it in its protective case when not in use. Clean the disc with a lint-free, soft, dry cloth, wiping in straight lines from center to outer edge. Never use solvents or abrasive cleaners.

# CONTENTS

Starting Up .....	2
Game Controls .....	3
Getting Started .....	4
Pac-Man .....	6
Pac-Man Arrangement .....	8
Galaga .....	11
Galaga Arrangement .....	15
Dig Dug .....	19
Dig Dug Arrangement .....	22
Pole Position .....	26
Pole Position II .....	29
Ms. Pac-Man .....	32
Galaxian .....	34
Pac-Attack (Locked) .....	36
Pac-Mania (Locked) .....	40
Credits .....	43

# STARTING UP

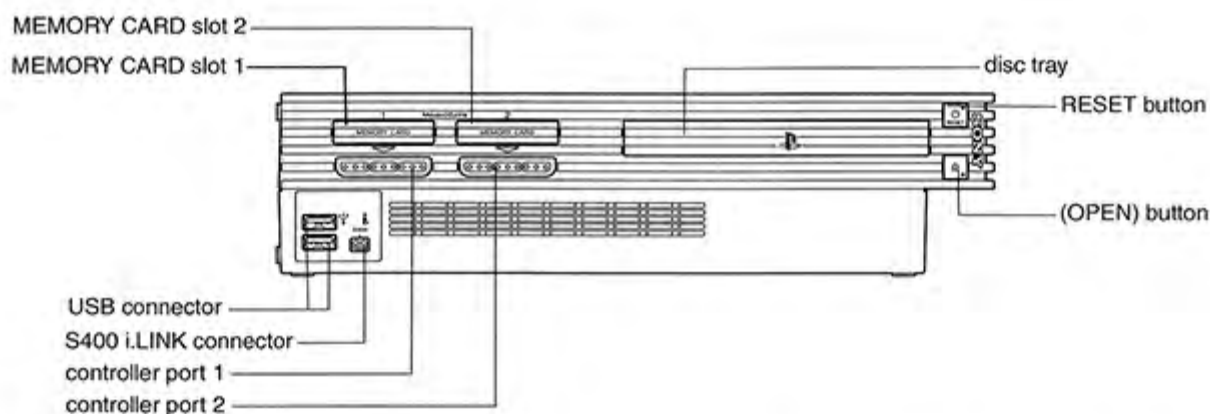

Set up your PlayStation®2 computer entertainment system according to the instructions in the Instruction Manual. Make sure the MAIN POWER switch (located on the back of the console) is turned on. Press the RESET button. When the power indicator lights up, press the OPEN button and the disc tray will open. Place the NAMCO MUSEUM disc on the disc tray with the label side facing up. Press the OPEN button again and the disc tray will close. Attach game controllers and other peripherals, as appropriate. Follow on-screen instructions and refer to this manual for information on using the software.

## BOOT UP

Insert a Memory Card (8MB) (for PlayStation®2) before booting up to be able to Save and Load High Scores and Options. If you have High Scores and Options saved on the memory card (for PlayStation®2) already, they are loaded at this time.



# GAME CONTROLS

## DUALSHOCK®2 ANALOG CONTROLLER CONFIGURATIONS

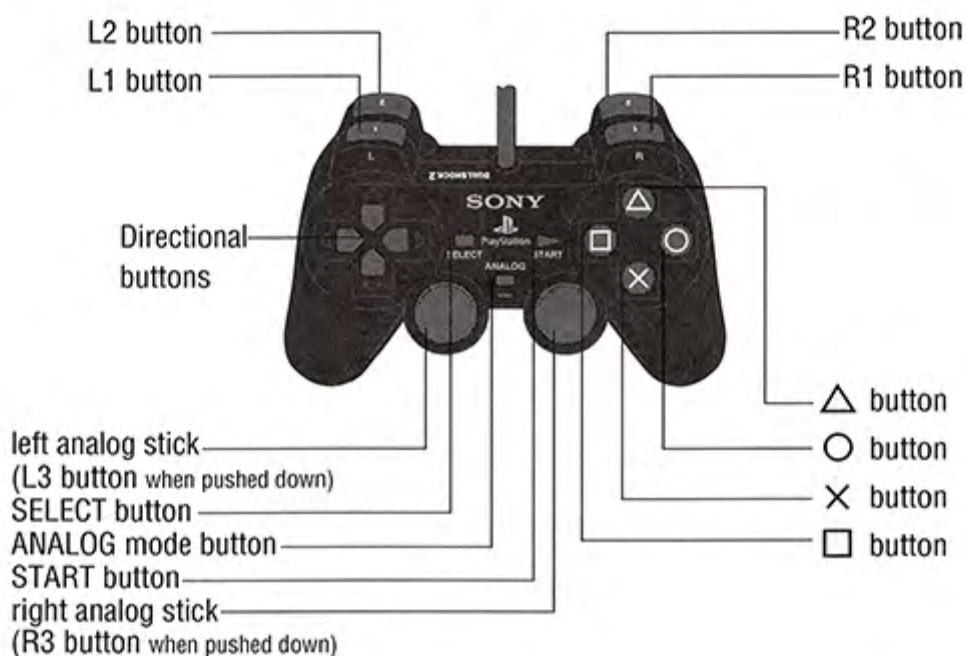

## CONTROLLER



Controller operation is the same, aside from Analog Mode.

# GETTING STARTED

## TITLE SCREEN

Stays on until the  button or the START button is pressed. When pressed, you are taken to the Main Menu.



## MAIN MENU

Controls on the Main Menu:

- The player can highlight a game by pressing the Directional buttons or left analog stick left, right, up or down. The games are listed in the following order:

1. **Pac-Man**
2. **Pac-Man Arrangement**
3. **Galaga**
4. **Galaga Arrangement**
5. **Dig Dug**
6. **Dig Dug Arrangement**
7. **Pole Position**
8. **Pole Position II**
9. **Ms. Pac-Man**
10. **Galaxian**
11. **Pac-Attack (Locked)**
12. **Pac-Mania (Locked)**



- Pressing the  button selects the game.
- Pressing the START button displays the Main Menu Options.

## MAIN MENU OPTIONS



**Volume:** Press the Directional buttons right/left to adjust the music and sound effects volume.

**Start Up Mode:** Determines whether the test patterns from the original arcade machine are displayed.



**Vibration:** Press the Directional buttons right/left to turn on or off the Vibration function.

**Restore Initial Settings:** Restores all Main Menu Options and each game's Settings to their default setting.

**Credits:** Select this to view the credits. Press the Directional buttons up/down to speed up the scroll. Press the  or  button to return to the Main Menu.

**Load High Scores / Options:** Select this to load High Scores and Options from your memory card (PS2). Insert a memory card (PS2) in MEMORY CARD slot 1.

**Save High Scores / Options:** Select this to save High Scores and Options to your memory card (PS2). Insert a memory card (PS2) in MEMORY CARD slot 1.

**Done:** Select this to return to the Main Menu.



# PAC-MAN™

**How to Play the Game:** The purpose of the game is to eat all the Pac-Dots from each maze while avoiding the attacks of the four ghosts. When all the Pac-Dots are eaten up, Pac-Man can proceed to the next round.

## Rules:

- If you touch a ghost, Pac-Man will lose one life.
- The game is over when all lives are lost.
- An extra life is awarded by scoring 10,000 points. (This value is on the Settings Screen and can be changed with the Bonus Option.)

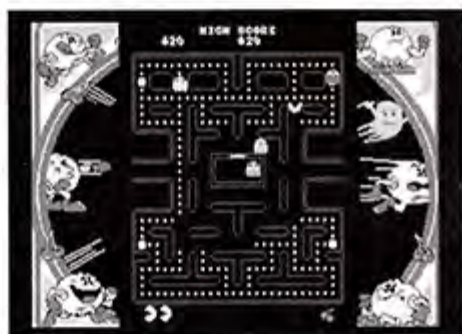

**Power Pellets:** Chomp down on a power pellet and Pac-Man will have the power to eat ghosts. When a power pellet is eaten, the ghosts change to a dark blue color for a short time. The ghosts start flashing before they turn back to their normal color, so watch out! After a ghost has been eaten, its eyes return to the Ghost Home, then the ghost is regenerated. The more ghosts Pac-Man eats in succession, the more points they are worth.

**Fruit:** Fruit appears twice in each maze. Munch these for bonus points. The more mazes you complete, the more the fruit is worth.

**Warp Tunnels:** Go through these tunnels and Pac-Man will appear out on the other side of the maze. Use them to slow down a ghost that's hot on your tail.

## How to use the Controller:

**Start 1 Player Game:** Press the  button.

**Start 2 Player Game:** Press the  button.

**Insert Credits:** Press the  button.

**Options:** Press the START button.

- **Continue:** This will return you to game play.
- **Settings:** This screen allows you to change the following settings:
  - Lives** - Choose to start with 1, 2, 3 or 5 lives.



**Bonus** - Set the point value that must be reached to earn an extra life.

1. 10,000 points
2. 15,000 points
3. 20,000 points
4. None

**Volume** - Press the Directional buttons right/left to adjust the music and sound effects volume.

**Done** - Select this to return to the Options Window.



- **Tips:** This option opens up a list of tips for Pac-Man. You can scroll through by pressing the Directional buttons right/left. This option can be exited by pressing the **▲** button at any time or by highlighting Done and pressing the **⊗** button.



- **Screen Size:** This allows you to select the size of the game window: Normal, Medium or Small. This is to compensate for some televisions that display text beyond the viewable screen boundaries.
- **Return To Main Menu:** Returns you to the Main Menu.

### Arcade Controls:

- During game play, the Directional button or left analog stick controls the movements of Pac-Man.
- To Pause during the game, press the START button. This will bring up the Pause Options with the following choices:
  - Continue** ..... This will return you to game play.
  - Quit Game** ..... This will return you to the Pac-Man Title Screen.
  - Volume** ..... Press the Directional buttons right/left to adjust the music and sound effects volume.
  - Screen Size** ..... This allows you to select the size of the game window: Normal, Medium or Small.
  - Return To Main Menu** ... Returns you to the Main Menu.





TM

**How to Play the Game:** The purpose of the game is to have Pac-Man chomp all the Pac-Dots from each maze while avoiding the attacks of the ghosts. When all the Pac-Dots are eaten up, Pac-Man proceeds to the next round. Defeat the Final Boss and you win the game.

### Rules:

- If you touch a ghost, Pac-Man will lose one life.
- The game is over when all lives are lost.
- An extra life is awarded by scoring 40,000 points. (This value is on the Settings Screen and can be changed with the Bonus Option.)



**Power Pellets:** Chomp down on a power pellet and Pac-Man will have the power to eat ghosts. When a power pellet is eaten, the ghosts change to a dark blue color for a short time. The ghosts start flashing before they turn back to their normal color, so watch out! After a ghost has been eaten, its eyes return to the Ghost Home, then the ghost is regenerated. The more ghosts Pac-Man eats in succession, the more points they are worth.

**Fruit:** Fruit appears twice in each maze. Munch these for bonus points. The more mazes you complete, the more the fruit is worth.

**Warp Tunnels:** Go through these tunnels and Pac-Man appears on the other side of the maze. Use them to slow down a ghost that's hot on your tail.

**Pac-Dash Arrows:** Gobble up one of these arrows and Pac-Man gets a huge burst of speed in the direction indicated. He'll quickly gobble up any vulnerable blue ghosts he runs into. If the ghosts aren't vulnerable, he'll stun them.

**Warp Gate:** Go through a gate and Pac-Man is shot to the opposite gate of the same color. These gates can also be used for quick getaways.

**Large Ghosts:** The large ghosts were given special abilities to catch Pac-Man, so watch out! Some large ghosts can rush like a bull, jump across the maze like a rabbit or even be in two places at the same time.

**Power Ups:** These items can be used to help Pac-Man advance to the next maze.

**Brown Sack** .....Holds the ghosts for a short period of time.

**Magic Wand**.....Turns all the ghosts into presents.

**Pink Power Up**.....Traps ghosts in a brown sack for a short time.

**Blue Power Up**.....Allows Pac-Man to be in two places at the same time.

**Red Power Up** .....Gives Pac-Man a speed boost.

**Orange Power Up**....Can be eaten for extra points.

### How to use the Controller:

**Start 1 Player Game:** Press the  button.

**Start 2 Player Game:** Press the  button.

**Options:** Press the START button.

- **Continue:** This will return you to game play.
- **Settings:** This screen allows you to change the following settings:

**Difficulty** - Choose to play the game on: Easy, Normal, Hard, Very Hard or Ultra Hard.

**Lives** - Choose to start with 2, 3, 4, 5 or 6 lives.



**Bonus** - Set the point value that must be reached to earn an extra life.

1. 40,000 points and 100,000 points
2. 40,000 points only
3. None

**Volume** - Press the Directional buttons right/left to adjust the music and sound effects volume.

**Done** - Select this to return to the Options Window.



- **Tips:** This option opens up a list of tips for Pac-Man Arrangement. You can scroll through by pressing the Directional buttons right/left. This option can be exited by pressing the  button at any time or by highlighting Done and pressing the  button.



- **Screen Size:** This allows you to select the size of the game window: Normal, Medium or Small. This is to compensate for some televisions that display text beyond the viewable screen boundaries.
- **Return To Main Menu:** Returns you to the Main Menu.

### Arcade Controls:

- During game play, the Directional button or left analog stick controls the movements of Pac-Man.
- To Pause during the game, press the START button. This will bring up the Pause Options with the following choices:

- Continue** ..... This will return you to game play.
- Quit Game** ..... This will return you to the Pac-Man Arrangement Title Screen.
- Volume** ..... Press the Directional buttons right/left to adjust the music and sound effects volume.
- Screen Size** ..... This allows you to select the size of the game window: Normal, Medium or Small.
- Return To Main Menu** ... Returns you to the Main Menu.



# Galaga™

**How to Play the Game:** When the game is started, the Galaga alien formation appears and assembles in the upper part of the screen. Soon after that, they start attacking. Your star fighter is operated by moving to the left or right. When Galaga troops come flying down to attack, you can defeat them with your missiles. When all the enemies have been defeated, you can proceed to the next round.

## Rules:

- You lose one star fighter when you are hit with an enemy's missile or when you touch the enemy.
- The game is over when all lives are lost.
- If your Lives setting is set to 2, 3, 4, or 5, one star fighter is awarded when you score 20,000 points, 70,000 points and for every 70,000 points after that. If you set your lives to 5, the first bonus fighter is awarded at 30,000 points and every 120,000 points after that.
- It is possible to change Lives and Bonuses separately.



## Let's fight with a Dual Fighter!

- When two fighters are combined into one unit, your fighter has double the firepower. This fighter is called a Dual Fighter. Let's start a major attack!

First, let Boss Galaga capture your fighter with his tractor beam.



A fighter has been captured and Boss Galaga is flying at you. Take your aim and fire!



A fighter rescue mission was successfully completed. A single fighter has changed into a Dual Fighter!

### Hints:

- If you shoot a captured fighter, the fighter will be destroyed. Be very careful and aim only at Boss Galaga!
- Be careful if there are no more fighters left and you are surrounded by a tractor beam; the game ends if your last fighter is captured.
- Attack Boss Galaga while he is flying! When a Boss Galaga with a captured fighter is attacked in formation, the captured fighter becomes your enemy!

### Your Chance to Win Big Points in the Challenging Stage!

The first challenging stage occurs on the third stage and on every fourth stage after that. Various types of Galagas will be flying in dancing formations. Since you can only obtain bonus points for the number of enemies that are defeated, you should shoot down as many as possible. Shoot down all enemies to get a perfect bonus.

## How to use the Controller:

**Start 1 Player Game:** Press the **X** button.

**Start 2 Player Game:** Press the **□** button.

**Insert Credits:** Press the **△** button.

**Options:** Press the START button.

- **Continue:** This will return you to game play.
- **Settings:** This screen allows you to change the following settings:

**Lives** - Choose to start with 2, 3, 4 or 5 lives.

**Bonus** - Set the point value that must be reached to earn an extra life.

1. 20,000 points and 60,000 points.
2. 20,000 points and 70,000 points.
3. 20,000 points and 80,000 points.
4. 30,000 points and 80,000 points.
5. 30,000 points and 100,000 points.
6. 30,000 points and 120,000 points.
7. None

\* These values change if the Lives Setting is 5.

**Volume** - Press the Directional buttons right/left to adjust the music and sound effects volume.

**Done** - Select this to return to the Options Window.

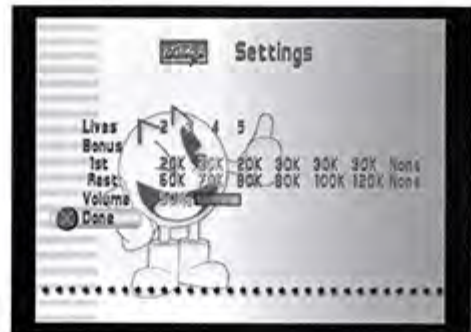

- **Tips:** This option opens up a list of tips for Galaga. You can scroll through by pressing the Directional buttons right/left. This option can be exited by pressing the **△** button at any time or by highlighting Done and pressing the **X** button.



- **Screen Size:** This allows you to select the size of the game window: Normal, Medium or Small. This is to compensate for some televisions that display text beyond the viewable screen boundaries.
- **Return To Main Menu:** Returns you to the Main Menu.

### Arcade Controls:

- During game play the Directional button or left analog stick controls the horizontal motion of the user's ship.
- The **X**, **L1** and **R1** buttons cause the player's ship to fire.
- To Pause during the game, press the START button. This will bring up the Pause Options where you have the following choices:
  - Continue** ..... This will return you to game play.
  - Quit Game** ..... This will return you to the Galaga Title Screen.
  - Volume** ..... Press the Directional buttons right/left to adjust the music and sound effects volume.
  - Screen Size** ..... This allows you to select the size of the game window: Normal, Medium or Small.
  - Return To Main Menu** ... Returns you to the Main Menu.







TM

**How to Play the Game:** When the game is started, the Galaga alien formation appears and assembles in the upper part of the screen. Soon after that, they start attacking. Your star fighter is operated by moving to the left or right. When Galaga troops come flying down to attack, you can defeat them with your missiles. When all the enemies have been defeated, you can proceed to the next round.

### Rules:

- You lose one star fighter when you are hit with an enemy's missile or when you touch the enemy.
- The game is over when all lives are lost.
- One star fighter is awarded when you score 50,000 points.
- It is possible to change Lives and Bonuses separately.



### Let's Power Up the Fighter!

- When two fighters are combined into one unit, your unit has double the firepower. Depending on which Boss Galaga captures your ship, you will receive a different weapon. There are three different power-ups to obtain. Let's start a major attack!

First, let the Boss Galaga capture your fighter with his tractor beam. Each Boss has a different color tractor beam - so you can pick the one you want to use.





Wide Beam



Fast Shot



Ricochet Shot



A fighter has been captured and Boss Galaga is flying at you. Take your aim and fire!

A fighter rescue mission was successfully completed. A single fighter has changed into a powered-up fighter!



### Hints:

- If you shoot a captured fighter, the fighter will be destroyed. Be very careful and aim only at Boss Galaga!
- Be careful if there are no more fighters left and you are surrounded by a tractor beam; the game ends if your last fighter is captured.

- You can attack a Boss Galaga while he's still in formation with a captured fighter to free the fighter. This is possible in Galaga Arrangement but not Galaga.

## Your Chance to Win Big Points in the Challenging Stage!

Various types of Galagas will be flying in dancing formations. Since you can only obtain bonus points for the number of enemies that are defeated, you should shoot down as many as possible. Shoot down all enemies to get a perfect bonus.

### How to use the Controller:

**Start 1 Player Game:** Press the **X** button.

**Start 2 Player Game:** Press the **□** button.

**Insert Credits:** Press the **△** button.

**Options:** Press the START button.

- **Continue:** This will return you to game play.
- **Settings:** This screen allows you to change the following settings:

**Difficulty** - Choose to play the game on: Easy, Normal, or Hard.

**Lives** - Choose to start with 2, 3, 4 or 5 lives.

**Bonus** - Set the point value that must be reached to earn an extra life.

1. 50,000 and 200,000 points.

2. 50,000 points only.

3. None

**Volume** - Press the Directional buttons right/left to adjust the music and sound effects volume.

**Done** - Select this to return to the Options Window.



- **Tips:** This option opens up a list of tips for Galaga Arrangement. You can scroll through by pressing the Directional buttons right/left. This option can be exited by pressing the **△** button at any time or by highlighting Done and pressing the **X** button.



- **Screen Size:** This allows you to select the size of the game window: Normal, Medium or Small. This is to compensate for some televisions that display text beyond the viewable screen boundaries.
- **Return To Main Menu:** Returns you to the Main Menu.

### Arcade Controls:

- During game play the Directional button or left analog stick controls the horizontal motion of the user's ship.
- The **X**, **□**, **L1** and **R1** buttons cause the player's ship to fire.
- To Pause during the game, press the START button. This will bring up the Pause Options where you have the following choices:
  - Continue** ..... This will return you to game play.
  - Quit Game** ..... This will return you to the Galaga Arrangement Title Screen.
  - Volume** ..... Press the Directional buttons right/left to adjust the music and sound effects volume.
  - Screen Size** ..... This allows you to select the size of the game window: Normal, Medium or Small.
  - Return To Main Menu** ... Returns you to the Main Menu.

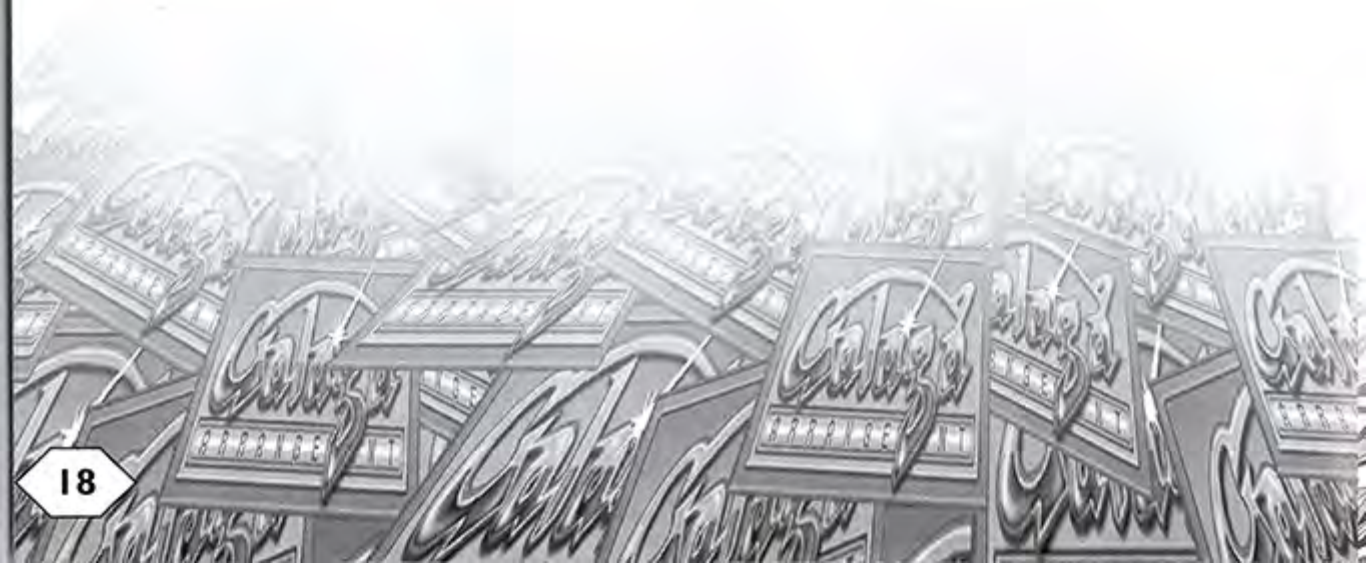



**How to Play the Game:** Move Dig Dug and dig up the ground layers. Then use your pump to pop and eliminate the enemies or crush them with rocks, while avoiding their attacks.

**Rules:**

- You lose a life if you are caught by the enemies, touch Fygar's fire or get crushed by a rock.
- The game is over when all the lives are lost.
- An extra life is awarded when scoring 20,000 points and 60,000 points. (This value is on the Settings Screen and can be changed with the Bonus Option).
- The Continue Screen appears when the game is over. You can continue playing the game by pressing the **X** button before the countdown reaches zero.

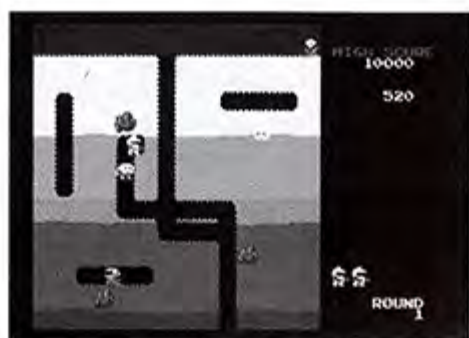

**Vegetables:** A vegetable appears if you drop two rocks during each round. The more stages you clear, the more the vegetables are worth.

**How to use the Controller:**

**Start 1 Player Game:** Press the **X** button.

**Start 2 Player Game:** Press the **□** button.

**Insert Credits:** Press the **△** button.

**Options:** Press the START button.

- **Continue:** This will return you to game play.
- **Settings:** This screen allows you to change the following settings:



**Difficulty** - Choose to play the game on: Easy, Normal, Hard or Expert.

**Lives** - Choose to start with 1, 2, 3 or 5 lives.

**Bonus** - Set the point value that must be reached to earn an extra life.



1. 10,000 points, 40,000 points and then every 40,000 points after.
2. 10,000 points, 40,000 points.
3. 10,000 points, 50,000 points and then every 50,000 points after.
4. 10,000 points.
5. 20,000 points, 60,000 points and then every 60,000 points after.
6. 20,000 points, 60,000 points.
7. 20,000 points, 70,000 points and then every 70,000 points after.
8. None

\* These values change if the Lives Setting is 5.

**Screen Scroll** - This option sets the screen to scroll up and down as Dig Dug moves when set to On or it forces the screen to remain stationary when set to Off.

**Volume** - Press the Directional buttons right/left to adjust the music and sound effects volume.

**Done** - Select this to return to the Options Window.

- **Tips:** This option opens up a list of tips for Dig Dug. You can scroll through by pressing the Directional buttons right/left. This option can be exited by pressing the  button at any time or by highlighting Done and pressing the  button.



- **Screen Size:** This allows you to select the size of the game window: Normal, Medium or Small. This is to compensate for some televisions that display text beyond the viewable screen boundaries.
- **Return To Main Menu:** Returns you to the Main Menu.

## Arcade Controls:

- During game play, the Directional button or left analog stick controls Dig Dug's movement.
- The **X**, **L1** and **R1** buttons cause Dig Dug to shoot his pump. After hitting an enemy, press three more times to cause the enemy to inflate and explode.
- To Pause during the game, press the **START** button. This will bring up the Pause Options where you have the following choices:
  - Continue** ..... This will return you to game play.
  - Quit Game** ..... This will return you to the Dig Dug Title Screen.
  - Volume** ..... Press the Directional buttons right/left to adjust the music and sound effects volume.
  - Screen Size** ..... This allows you to select the size of the game window: Normal, Medium or Small.
  - Return To Main Menu** .. Returns you to the Main Menu.



TM

**How to Play the Game:** Move Dig Dug and dig up the ground layers. Then use your pump to pop and eliminate the enemies or crush them with rocks, while avoiding their attacks.

### Rules:

- You lose a life if you are caught by the enemies, touch Fygar's fire, get hit by a fireball, get crushed by a rock or get popped.
- The game is over when all the lives are lost.
- An extra life is awarded when scoring 50,000 points. (This value is on the Settings Screen and can be changed with the Bonus Option).
- The Continue Screen appears when the game is over. You can continue playing the game by pressing the  button before the countdown reaches zero.



**Vegetables:** A vegetable appears if you drop two rocks during each round. The more stages you clear, the more the vegetables are worth.

### New Characters!

This little guy has a spike on his head that he uses to attack you with a charge move. Try to take him out from above or below.



Watch out for this one. He will explode when he is nearby and destroy an area around him. If you pump him, you can use him to take out the bad guys as well.





He seems to have the same abilities as you! He can even pump you up! He may resist being pumped, so be sure you act quickly! Watch out for the rocks he may drop!

This fellow has fireballs that will melt ice and destroy portions of the environment. Don't get too close and hide - he may get you!



Silly aliens more interested in sleeping than attacking. Be careful, they may awaken when you least expect it!

### **Boss Fight!**

You will have to overcome several large Bosses to beat the game. You will encounter the Boss Pooka and the Boss Fygar! These bosses are too large to inflate by yourself. Use the enemies on screen to help defeat them!

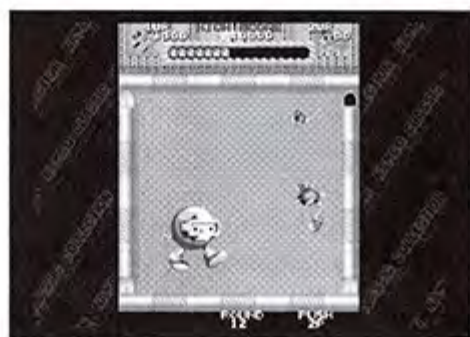

## How to use the Controller:

**Start 1 Player Game:** Press the **X** button.

**Start 2 Player Game:** Press the **□** button.

**Insert Credits:** Press the **△** button.

**Options:** Press the START button.

- **Continue:** This will return you to game play.
- **Settings:** This screen allows you to change the following settings:

**Difficulty** - Choose to play the game on: Easy, Normal, or Hard.

**Lives** - Choose to start with 1, 2, 3 or 5 lives.

**Bonus** - Set the point value that must be reached to earn an extra life.

1. 50,000 and 150,000 points.

2. 50,000 points only.

3. None

**Volume** - Press the Directional buttons right/left to adjust the music and sound effects volume.

**Done** - Select this to return to the Options Window.

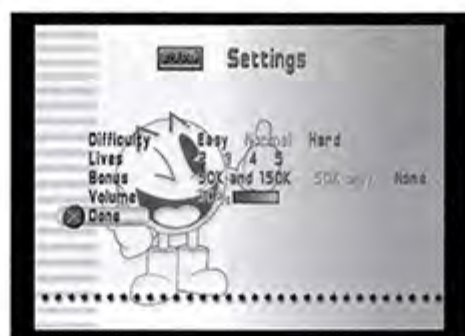

- **Tips:** This option opens up a list of tips for Dig Dug. You can scroll through by pressing the Directional buttons right/left. This option can be exited by pressing the **△** button at any time or by highlighting Done and pressing the **X** button.

- **Screen Size:** This allows you to select the size of the game window: Normal, Medium or Small. This is to compensate for some televisions that display text beyond the viewable screen boundaries.



- **Return To Main Menu:** Returns you to the Main Menu.

## Arcade Controls:

- During game play, the Directional button or left analog stick controls Dig Dug's movement.
- The **X**, **L1** and **R2** buttons cause Dig Dug to shoot his pump. After hitting an enemy, press three more times to cause the enemy to inflate and explode.
- To Pause during the game, press the START button. This will bring up the Pause Options where you have the following choices:
  - Continue** ..... This will return you to game play.
  - Quit Game** ..... This will return you to the Dig Dug Arrangement Title Screen.
  - Volume** ..... Press the Directional buttons right/left to adjust the music and sound effects volume.
  - Screen Size** ..... This allows you to select the size of the game window: Normal, Medium or Small.
  - Return To Main Menu** ... Returns you to the Main Menu.



# POLE POSITION™

**How to Play the Game:** You control the car's steering, acceleration, braking and shifting of gears. The acceleration and brake are analog if a DUALSHOCK®2 analog controller is used.

First, you must qualify for the main race by completing one lap with a fast lap time. If successful, you receive your starting position for the main race. If you take too long on the qualifying lap, you won't qualify for the main race.

When starting the main race, you begin from the position that you qualified. The race starts when the light turns green and you must successfully complete four laps to finish the race. As the race progresses, you should avoid crashing into other cars or obstacles on the sides of the racetrack. Also avoid driving over water puddles, since these slow you down.

You will receive additional race time for each lap that you complete by crossing the Start/Finish line. In the main race, if the time reaches zero before you cross the Start/Finish line, the game is over.



## Hints:

- Shift into low gear, tap the brake or let off on the accelerator to slow down for sharp turns.
- When approaching traffic, try to drive between opposing cars by positioning your car in the center of the track. Beware of cars that change lanes!

## How to use the Controller:

**Start 1 Player Game:** Press the **X** button.

**Insert Credits:** Press the **△** button.

**Options:** Press the START button.

- **Continue:** This will return you to game play.
- **Settings:** This screen allows you to change the following settings:

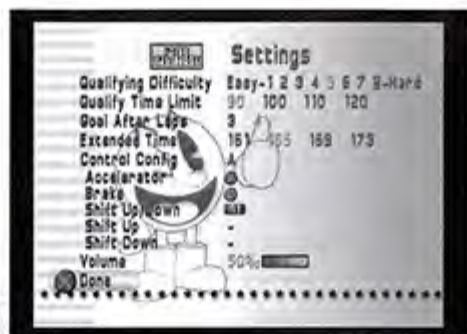

**Qualifying Difficulty** - This option sets the Qualifying Difficulty of game play between a value of 1 (easy) to 8 (hard).

**Qualify Time Limit** - This option sets the Qualifying Time Limit for the race to 90, 100, 110 or 120.



**Goal After Laps** - Choose between 3 or 4 laps for the main race.

**Extended Time** - This option selects between the amount of extended time you can earn. If the Goal After Laps option is set to 3, the user can select from 102, 105, 108 and 111. If the Goal After Laps option is set to 4, you can select from 161, 165, 169 and 173.

**Control Config** - This selects the controller configuration. There are 8 to choose from.

**Volume** - Press the Directional buttons right/left to adjust the music and sound effects volume.



**Done** - Select this to return to the Options Window.

- **Tips:** This option opens up a list of tips for Pole Position. You can scroll through by pressing the Directional buttons right/left. This option can be exited by pressing the  button at any time or by highlighting Done and pressing the  button.



- **Screen Size:** This allows you to select the size of the game window: Normal, Medium or Small. This is to compensate for some televisions that display text beyond the viewable screen boundaries.
- **Return To Main Menu:** Returns you to the Main Menu.

### Arcade Controls:

- During game play the Directional button or left analog stick controls your car's steering left/right.
- Default Controller Configuration with an DUALSHOCK®2 analog controller:
  -  button - Accelerate
  -  button - Apply Brake
  - R1** button - Shift Up/Down

- To Pause during the game, press the START button. This will bring up the Pause Options where you will have the following choices:

**Continue** . . . . . This will return you to game play.

**Quit Game** . . . . . This will return you to the Pole  
Position Title Screen.

**Volume** . . . . . Press the Directional buttons right/  
left to adjust the music and sound  
effects volume.

**Screen Size** . . . . . This allows you to select the size of the  
game window: Normal, Medium or Small.

**Return To Main Menu** . . . Returns you to the Main Menu.



**How to Play the Game:** After starting a 1 Player game, press the Directional buttons left/right to choose one of four different race tracks, then press the  button.

You control the car's steering, acceleration, braking and shifting of gears. The acceleration and brake are analog if a DUALSHOCK®2 analog controller is used.

First, you must qualify for the main race (Grand Prix) by completing one lap with a fast lap time. If successful, when you cross the Start/Finish line after completing the lap, you will receive your starting position for the main race. If you take too long on the qualifying lap, you won't qualify for the main race.



When starting the main race, you will begin from the position that you qualified. You must successfully complete four laps to finish the race. As the race progresses, you should avoid crashing into other cars or obstacles on the sides of the racetrack. Also avoid driving over water puddles, since these slow you down.

You will receive additional race time for each lap that you complete by crossing the Start/Finish line. In the main race, if the time reaches zero before you cross the Start/Finish line, the game will be over.

**Hint:**

- If you drive over water puddles at 230 mph (370 km), you will have turbo charged power.



## How to use the Controller:

**Start 1 Player Game:** Press the **X** button.

**Insert Credits:** Press the **△** button.

**Options:** Press the START button.

- **Continue:** This will return you to game play.
- **Settings:** This screen allows you to change the following settings:

**Qualifying Difficulty** - This option sets the Qualifying Difficulty of game play to Easy, Normal, Hard or Expert.

**Qualify Time Limit** - This option sets the Qualifying Time Limit for the race to 90 or 120.

**Goal After Laps** - Choose between 3, 4, 5 or 6 laps for the main race.

**Extended Time** - This option sets the amount of extended time you can earn. You can choose between Easy, Normal, Hard or Expert. Easy gives you the most amount of time while Expert gives you the least.

**Speed** - This sets the speed indicator to km or mph.

**Control Config** - This selects the controller configuration. There are 8 to choose from.

**Volume** - Press the Directional buttons right/left to adjust the music and sound effects volume.

**Done** - Select this to return to the Options Window.



- **Tips:** This option opens up a list of tips for Pole Position II. You can scroll through by pressing the Directional buttons right/left. This option can be exited by pressing the **△** button at any time or by highlighting Done and pressing the **X** button.





- **Screen Size:** This allows you to select the size of the game window: Normal, Medium or Small. This is to compensate for some televisions that display text beyond the viewable screen boundaries.
- **Return To Main Menu:** Returns you to the Main Menu.

### Arcade Controls:

- During game play the Directional button or left analog stick controls your car's steering left/right.
- Default Controller Configuration with a DUALSHOCK®2 analog controller:

- ⊗ button - Accelerate
- Ⓚ button - Apply Brake
- R1** button - Shift Up/Down

- To Pause during the game, press the START button. This will bring up the Pause Options where you have the following choices:

- Continue** ..... This will return you to game play.
- Quit Game** ..... This will return you to the Pole Position II Title Screen.
- Volume** ..... Press the Directional buttons right/left to adjust the music and sound effects volume.
- Screen Size** ..... This allows you to select the size of the game window: Normal, Medium or Small.
- Return To Main Menu** ... Returns you to the Main Menu.

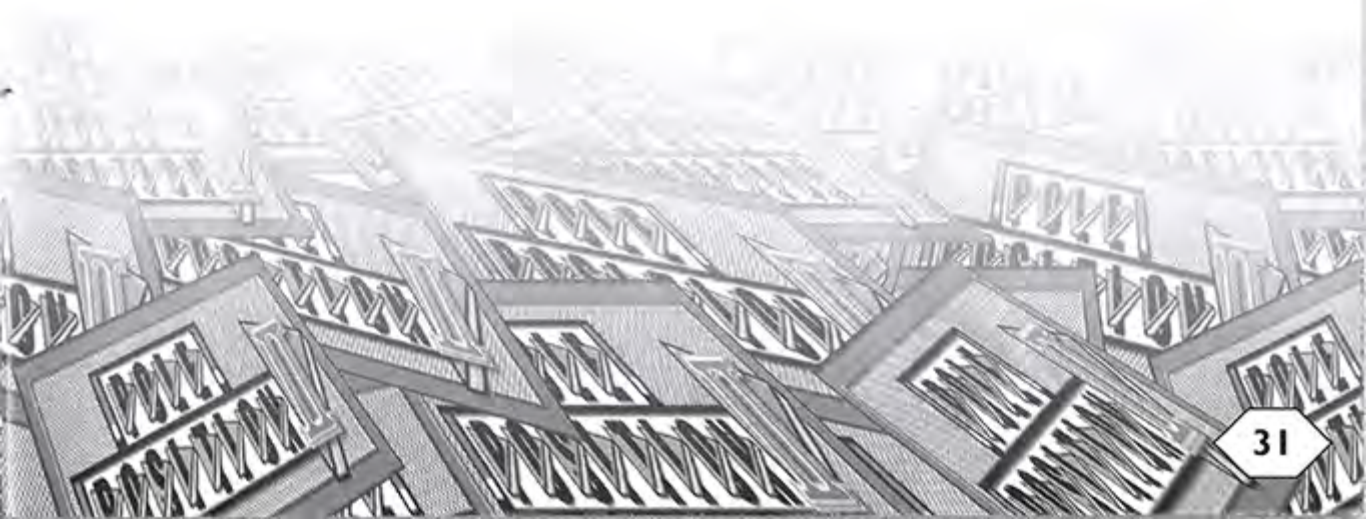

# MS. PAC-MAN

TM

**How to Play the Game:** The purpose of the game is to eat all the Pac-Dots from each maze while avoiding the attacks of the four ghosts. When all the Pac-Dots are eaten up you can proceed to the next round.

## Rules:

- If you touch a ghost, Ms. Pac-Man will lose one life.
- The game is over when all the lives are lost.
- An extra life is awarded by scoring 10,000 points. (This value is on the Settings Screen and can be changed with the Bonus Option).

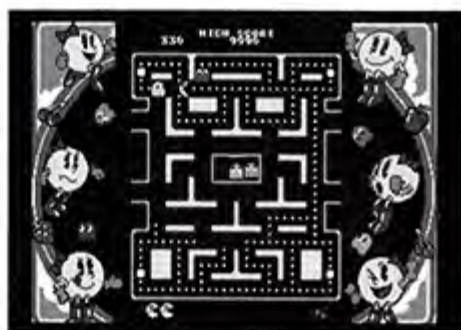

**Power Pellets:** Chomp down on a power pellet and Ms. Pac-Man will have the power to eat ghosts. When a power pellet is eaten, the ghosts change to a dark blue color for a short time. The ghosts will start flashing before they turn back to their normal color, so watch out! After a ghost has been eaten, its eyes return back to the Ghost Home, then the ghost will be regenerated. The more ghosts you eat in succession, the more points they are worth.

**Fruit:** Fruit appears twice in each maze. Munch these moving treats for bonus points. The more mazes you complete, the more the fruit is worth.

**Warp Tunnels:** Go through these tunnels and you'll appear on the other side of the maze. Use them to slow down a ghost that's hot on your tail.

## How to use the Controller:

**Start 1 Player Game:** Press the  button.

**Start 2 Player Game:** Press the  button.

**Insert Credits:** Press the  button.

**Options:** Press the START button.

- **Continue:** This will return you to game play.
- **Settings:** This screen allows you to change the following settings:

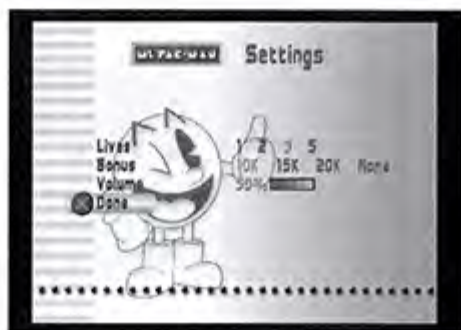

**Lives** - Choose to start with 1, 2, 3 or 5 lives.

**Bonus** - Set the point value that must be reached to earn an extra life.

1. 10,000 points
2. 15,000 points
3. 20,000 points
4. None

**Volume** - Press the Directional buttons right/left to adjust the music and sound effects volume.

**Done** - Select this to return to the Options Window.

- **Tips:** This option opens up a list of tips for Ms. Pac-Man. You can scroll through by pressing the Directional buttons right/left. This option can be exited by pressing the **▲** button at any time or by highlighting Done and pressing the **✕** button.



- **Screen Size:** This allows you to select the size of the game window: Normal, Medium or Small. This is to compensate for some televisions that display text beyond the viewable screen boundaries.
- **Return To Main Menu:** Returns you to the Main Menu.

### Arcade Controls:

- During game play, the Directional button or left analog stick controls the movements of Ms. Pac-Man.
- To Pause during the game, press the START button. This will bring up the Pause Options with the following choices:
  - Continue** ..... This will return you to game play.
  - Quit Game** ..... This will return you to the Ms. Pac-Man Title Screen.
  - Volume** ..... Press the Directional buttons right/left to adjust the music and sound effects volume.
  - Screen Size** ..... This allows you to select the size of the game window: Normal, Medium or Small.
  - Return To Main Menu** ... Returns you to the Main Menu.

# Galaxian™

**How to Play the Game:** The formations attack you one after another when the game starts. Your mission is to eliminate all the enemies to proceed to the next stage.

## Rules:

- You lose one star fighter when you are hit with an enemy's missile or when you touch the enemy.
- The game is over when all lives are lost.
- One star fighter is awarded by scoring 5,000 points. (This value is on the Settings Screen and can be changed with the Bonus Option).



## Hints:

- Eliminate the escorts! – Destroying the boss with one escort is worth 200 points; with two escorts it's 300 points. Eliminate both escorts first and then the boss to get 800 points.
- If you take too long to destroy the formation, or if there are only a few enemies left, they will start attacking very aggressively. Eliminate the enemies quickly!

## How to use the Controller:

**Start 1 Player Game:** Press the  button.

**Start 2 Player Game:** Press the  button.

**Insert Credits:** Press the  button.

**Options:** Press the START button.

- **Continue:** This will return you to game play.
- **Settings:** This screen allows you to change the following settings:

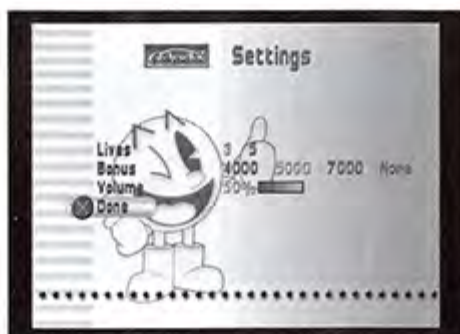

**Lives** - Choose to start with 3 or 5 lives.

**Bonus** - Set the point value that must be reached to earn an extra life.

1. 4,000 points

2. 5,000 points

3. 7,000 points

4. None

**Volume** - Press the Directional buttons right/left to adjust the music and sound effects volume.

**Done** - Select this to return to the Options Window.

- **Tips:** This option opens a list of tips for Galaxian. You can scroll through by pressing the Directional buttons right/left. This option can be exited by pressing the **▲** button at any time or by highlighting Done and pressing the **✕** button.



- **Screen Size:** This allows you to select the size of the game window: Normal, Medium or Small. This is to compensate for some televisions that display text beyond the viewable screen boundaries.
- **Return To Main Menu:** Returns you to the Main Menu.

### Arcade Controls:

- During game play the Directional button or left analog stick controls the horizontal motion of the user's ship.
- The **✕**, **L1** and **R1** buttons cause the player's ship to fire.
- To Pause during the game, press the START button. This will bring up the Pause Options where you have the following choices:
  - Continue** ..... This will return you to game play.
  - Quit Game** ..... This will return you to the Galaxian Title Screen.
  - Volume** ..... Press the Directional buttons right/left to adjust the music and sound effects volume.
  - Screen Size** ..... This allows you to select the size of the game window: Normal, Medium or Small.
  - Return To Main Menu** ... Returns you to the Main Menu.

# PAC-ATTACK

TM

Pac-Attack is a locked game. To unlock it, you have to score 25,000 points or more in Pac-Man. If you succeed, you'll be able to select Pac-Attack from the Main Menu. Be sure to save your High Scores/Options to a memory card (PS2) so it will remain unlocked when you load your High Scores/Options the next time you play.



**How to Play the Game:** Blocks fall from the top of the play screen. Twist and turn the blocks to line them up from left to right. When you fill up a line of blocks, they vanish. Oh, but nasty ghosts keep popping up to wreck the lines! You have to line them up too. Then your old friend Pac-Man pops in for some ghostly gobbling. Put him in the right place and he'll chomp ghosts 'til there aren't any more or he hits a block.

## Normal Mode:

This mode features you, Pac-Man and an occasional Fairy against the ghosts and an endless flock of falling blocks. Choose between Easy, Normal, Hard and Hyper difficulty levels.

- **Sneak Preview:** This box lets you look ahead to see the upcoming cluster containing blocks, ghosts, Fairies and Pac-Man.



- **Fairy Meter:** Each time Pac-Man chomps a ghost, a bit of gold dust goes into the Fairy Meter. When it's filled, a Fairy appears in the Sneak Preview box. When difficulty is set to Easy, the Meter doesn't rise but the Fairy will appear once. When the Fairy appears, press the Directional button or left analog stick to move the Fairy. When she stops, she throws a spell that knocks off all the Ghosts below it!

**Score:** Your score so far.

**Level:** Your current speed level.

**Fairies:** You have more help in this game than just a voracious Pac-Man.

### **Puzzle Mode:**

Puzzle Mode is 100 stages of Pac-Attack madness. Complete a stage and you get a Password. The next time you play, the Password lets you continue from a previous game position so you don't have to start all over again. Choose

**Password** on the Puzzle Prompt to input a password. In Puzzle Mode, you can turn Pac-Man left/right with the **L1** and **R1** buttons.



- **Next:** Lets you look ahead to see the upcoming cluster of blocks, ghosts and Pac-Man.
- **Rest:** Keeps track of how many more times Pac-Man will appear in the stage.
- **Stage:** Shows the current Puzzle stage.
- **Password:** Shows the Password for the stage.

**Appendix for Puzzle Mode:** Appendix lets you play Puzzle Mode with Pac-Man appearing less often, but the clusters are consistent rather than random. To play Appendix, highlight **Puzzle Mode**, hold right on the Directional button and press the **X** button. The Appendix graphic will appear.

## Versus Mode/2 Player Mode:

It's a dueling Pac-Attack chomp-a-thon! Whoever survives the longest wins the round. The first player to win three rounds takes the Chomp Champ Title! If Pac-Man eats more than five ghosts, some of them run over to haunt the opponent's side. Each player can select a different speed level.

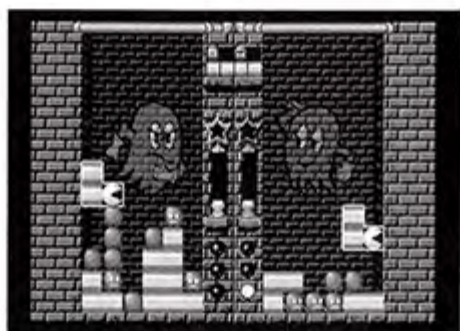

**Rounds Won:** The filled-in circles show the rounds won for each player.



## How to use the Controller:

**Options:** Press the START button.

- **Continue:** This will return you to game play.
- **Settings:** This screen allows you to change the following settings:

**Volume** - Press the Directional buttons right/left to adjust the music and sound effects volume.

**Done** - Select this to return to the Options Window.

- **Tips:** This option opens up a list of tips for Pac-Attack. You can scroll through by pressing the Directional buttons right/left. This option can be exited by pressing the  button at any time or by highlighting Done and pressing the  button.

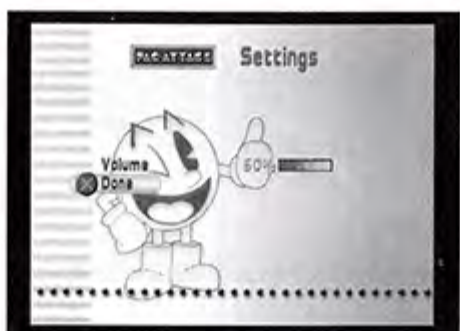



- **Screen Size:** This allows you to select the size of the game window: Normal, Medium or Small. This is to compensate for some televisions that display text beyond the viewable screen boundaries.
- **Return To Main Menu:** Returns you to the Main Menu.

### Arcade Controls:

- During game play, press the Directional buttons or left analog stick left/right to slide the block clusters left and right.
- Press the Directional button down to slide block clusters down quickly.
- The **X** button rotates block clusters clockwise.
- The **Y** button rotates block clusters counter-clockwise.
- The **L1** and **R1** buttons make Pac-Man face left/right in Puzzle Mode.
- To Pause during the game, press the START button. This will bring up the Pause Options where you have the following choices:

- Continue** ..... This will return you to game play.
- Quit Game** ..... This will return you to the Pac-Attack Title Screen.
- Volume** ..... Press the Directional buttons right/left to adjust the music and sound effects volume.
- Screen Size** ..... This allows you to select the size of the game window: Normal, Medium or Small.
- Return To Main Menu** . . . Returns you to the Main Menu.



Pac-Mania is a locked game. To unlock it, you have to score 20,000 points or more in Ms. Pac-Man. If you succeed, you'll be able to select Pac-Mania from the Main Menu. Be sure to save your High Scores/Options to a memory card (PS2) so it will remain unlocked when you load your High Scores/Options the next time you play.



**How to Play the Game:** Move Pac-Man around the maze, avoiding ghosts and eating all the Pac-Dots. Munch all the Pac-Dots and you clear the round. The secret to winning is wise use of jumping and munching the power pellets.

#### Rules:

- If you touch a ghost, Pac-Man will lose a life.
- The game is over when all lives are lost.
- At 100,000 points Pac-Man receives an extra life. (This value is on the Settings Screen and can be changed with the Bonus Option.)

**Power Pellets:** Chomp down on a power pellet and Pac-Man will have the power to eat ghosts. When a power pellet is eaten, the ghosts change to a dark blue color for a short time. The ghosts start flashing before they turn back to their normal color, so watch out! After a ghost has been eaten, its eyes return to the Ghost Home and the ghost is regenerated. The more ghosts Pac-Man eats in succession, the more points they are worth.

**Fruit:** Fruit appears in each maze. Munch these for bonus points. The more mazes you complete, the more the fruit is worth.

**One-Way Areas:** Each round has one-way areas where ghosts never come from. Learn the patterns so you can find the shortcuts.

### How to use the Controller:

**Start 1 Player Game:** Press the  button.

**Start 2 Player Game:** Press the  button.

**Insert Credits:** Press the  button.

**Options:** Press the START button.

- **Continue:** This will return you to game play.
- **Settings:** This screen allows you to change the following settings:

**Difficulty** - Choose to play the game on: Easy, Normal, Hard or Very Hard.

**Lives** - Choose to start with 1, 2, 3, 4 or 5 lives.

**Bonus** - Set the point value that must be reached to earn an extra life.

1. 50,000 points
2. 100,000 points
3. 150,000 points
4. None



**Game End** - Sets when the game should end: 23rd Round, 11th Round or Endless.

**Play Mode** - Sets the game to Continue, Select or Retry 1st.

**Volume** - Press the Directional button right/left to adjust the music and sound effects volume.

**Done** - Select this to return to the Options Window.



- **Tips:** This option opens up a list of tips for Pac-Mania. You can scroll through by pressing the Directional buttons right/left. This option can be exited by pressing the  button at any time or by highlighting Done and pressing the  button.
- **Screen Size:** This allows you to select the size of the game window: Normal, Medium or Small. This is to compensate for some televisions that display text beyond the viewable screen boundaries.
- **Return To Main Menu:** Returns you to the Main Menu.



### Arcade Controls:

- During game play, the Directional button or left analog stick controls the movements of Pac-Man.
- The , **L1** and **R1** buttons cause Pac-Man to jump. He can jump over ghosts, but be careful - there are ghosts out there that can jump too!
- To Pause during the game, press the START button. This will bring up the Pause Options where you have the following choices:
  - Continue** ..... This will return you to game play.
  - Quit Game** ..... This will return you to the Pac-Mania Title Screen.
  - Volume** ..... Press the Directional buttons right/left to adjust the music and sound effects volume.
  - Screen Size** ..... This allows you to select the size of the game window: Normal, Medium or Small.
  - Return To Main Menu** .. Returns you to the Main Menu.

# Credits

## **NAMCO HOMETEK INC**

### **Producer**

Mike Lescault

### **Director of Marketing**

Stacey Sujishi

### **Quality Assurance Manager**

Brian Schorr

### **Project Coordinator**

James Guirao

### **Quality Assurance**

#### **Lead Analyst**

Daryle Tumacder

#### **Assistant Lead Analyst**

Michael Yim

### **Testers**

Matt Peterson

Mike Stevens

Ben Pascua

Glen Seward

Ryan Chennault

## **Package and Manual Design**

Price Design Team

## **Special Thanks**

Yoshi Homma

Jesse Taylor

Roman Scharnberg

Yas Noguchi

Robert Ennis

Berry Kane

Jennifer Tersigni

Hugo Reyes

## **Special Thanks to Namco Ltd**

Masaya Nakamura

Shigeru Yokoyama

Takefumi Hyodo

## **MASS MEDIA**

### **Executive Producer**

David Todd

### **Producer**

Bernie Whang



# Credits continued

## Lead Programmers

Dan Pinal  
Andy Green  
Bob Hickman  
Colby Koch

## Lead Artist

Robin Karlsson

## Music

Jim Andron

## Conversion Programmers

David Todd  
Nigel Spencer  
Rob Toone

## Software Tools Guru

Ken Jordan

## Additional Tools

Ken Dullea

## SFX Conversion / Additional Artwork

Bernie Whang

## Additional SFX Conversion

Andrew Burg

## Memory Card Icon Artwork

Jay Jang

## Testing

Donald Mendoza

## Technical Support

Mike DiGiacinto

## Namco Technical Assistance

Roman Scharnberg

## Special Thanks

Charlene Bahnhoff  
Mark Harwood  
Bob Celardo  
Bill McDonald

#### **LIMITED WARRANTY**

Namco Hometek Inc. warrants to the original purchaser that this Namco Hometek Inc. game pak shall be free from defects in material and workmanship for a period of ninety (90) days from the date of purchase. If a defect covered by this limited warranty occurs during this 90-day limited warranty period, Namco Hometek Inc. will repair or replace the defective game pak or component part, at its option, free of charge.

This limited warranty does not apply if the defects have been caused by negligence, accident, unreasonable use, modification, tampering, or any other cause not related to defective material or workmanship.

#### **LIMITATIONS ON WARRANTY**

Any applicable implied warranties of merchantability and fitness for a particular purpose, are hereby limited to ninety (90) days from the date of purchase and are subject to the conditions set forth herein. In no event shall Namco Hometek Inc. be liable for consequential or incidental damages resulting from the possession or use of this product.

The provisions of the limited warranty are valid in the United States only. Some states do not allow limitations on how long an implied warranty lasts, or exclusion of consequential or incidental damages, so the above limitation or exclusion may not apply to you. This limited warranty provides you with specific legal rights. You may have other rights which vary from state to state.

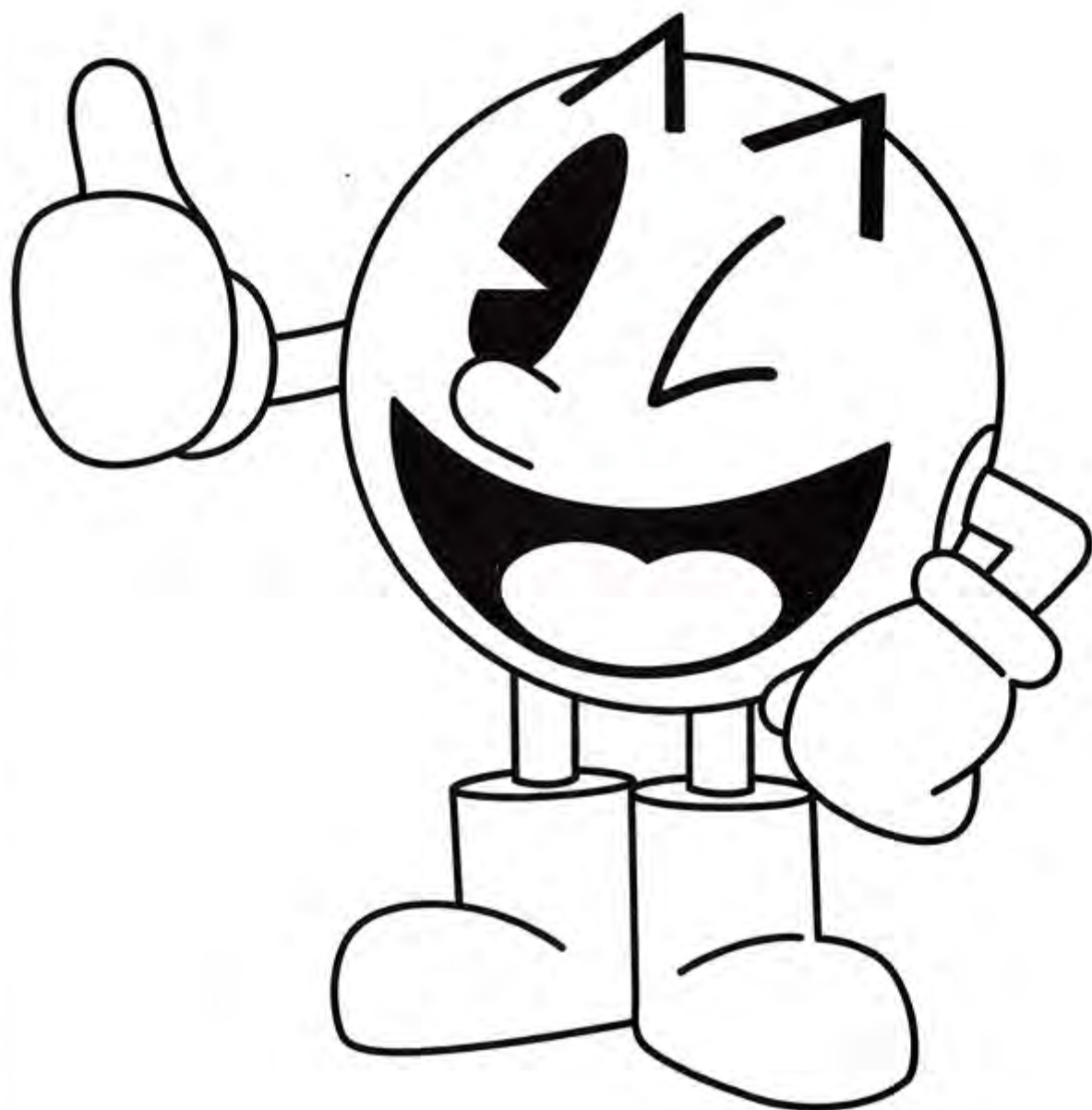

# PAC-MAN

Pac-Man TM ©1980-81 Namco

TM

# PAC-MAN

ARRANGEMENT

TM

# Galaga

TM

# Galaga

ARRANGEMENT

TM

# Dig Dug

TM

# Dig Dug

ARRANGEMENT

TM

# POLE

# POSITION

TM

# MS. PAC-MAN

TM

# POLE POSITION II

TM

# Galaxian

TM



Namco Homeent Inc., 2055 Junction Avenue, San Jose, CA 95131 [www.namco.com](http://www.namco.com)

NAMCOMUSEUM™ & © 2001 NAMCO LTD., ALL RIGHTS RESERVED. Pac-Man©1980 2001 NAMCO LTD., ALL RIGHTS RESERVED. Pac-Man Arrangement©1980 1996 2001 NAMCO LTD., ALL RIGHTS RESERVED. Dig Dug ©1982 2001 NAMCO LTD., ALL RIGHTS RESERVED. Dig Dug Arrangement©1982 1996 2001 NAMCO LTD., ALL RIGHTS RESERVED. Galaga©1981 2001 NAMCO LTD., ALL RIGHTS RESERVED. Galaga Arrangement©1981 1995 2001 NAMCO LTD., ALL RIGHTS RESERVED. Pole Position©1982 2001 NAMCO LTD., ALL RIGHTS RESERVED. Pole Position 2©1982 1983 2001 NAMCO LTD., ALL RIGHTS RESERVED. Ms. Pac-Man©1980 1982 2001 NAMCO LTD., ALL RIGHTS RESERVED. Galaxian©1979 2001 NAMCO LTD., ALL RIGHTS RESERVED. Pac-Attack©1993 2001 NAMCO LTD., ALL RIGHTS RESERVED. Pac-Mania©1980 1987 2001 NAMCO LTD., ALL RIGHTS RESERVED. Manufactured pursuant to license with Namco Holding Corp.

Licensed for play on the PlayStation 2 computer entertainment systems with the NTSC U/C designation only. "PlayStation" and the "PS" Family logo are registered trademarks of Sony Computer Entertainment Inc. The ratings icon is a registered trademark of the Interactive Digital Software Association. Manufactured and printed in the U.S.A. THIS SOFTWARE IS COMPATIBLE WITH PLAYSTATION 2 CONSOLES WITH THE NTSC U/C DESIGNATION. U.S. AND FOREIGN PATENTS PENDING.

# namco®